

Article number: 20958426

Description: E+G Levelling foot
GN 343.3-25-M8-G

Measures

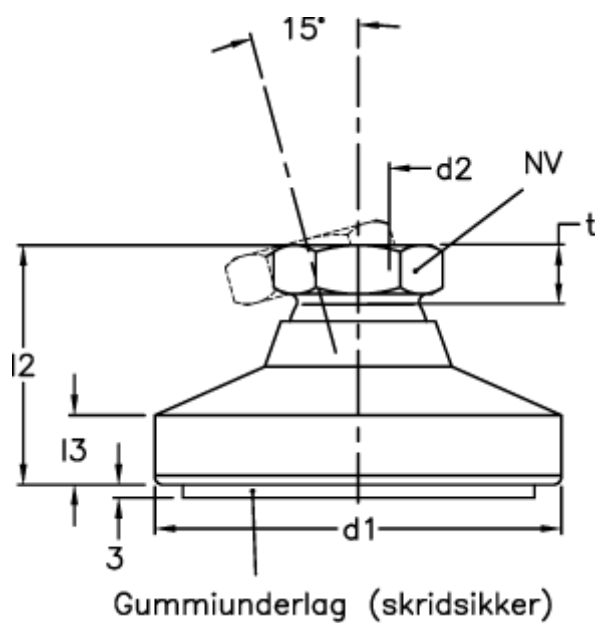

$d1$	= 25
$d2$	= M 8
$l2$	= 18.5
$l3$	= 4.0
NV	= 12.0
Static load (N)	= 5000
t min	= 9.0